

北极光 3535AV1

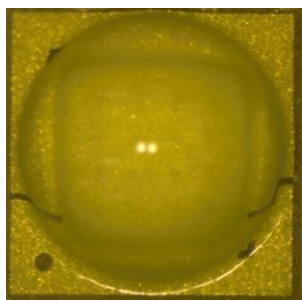

产品特点 Features

- 通过 LM80 可靠性认证
- 优异的光通维持率 (6000hours, $T_s=105^{\circ}\text{C}$, >97%)
- 业界领先的热学特性
- 业内领先的电压表现
- 完美的光色一致性, 为高品质照明环境专业设计
- 有效降低系统成本, 提供最优化解决方案

产品应用 Applications

- 室外照明领域
- 室内照明领域
- 筒灯
- 射灯
- 聚光灯
- 路灯

产品规格 Specification

产品色温	显色指数		光通量		正向电压		发光角度 典型值	器件热阻 典型值
	典型值		典型值	典型值	典型值	最大值		
	@350mA		@350mA	@700mA	@350mA	@350mA		
3000K	70		156lm	278lm	2.78V	2.95V	140°	5.5°C/W
4000K	70		172lm	306lm	2.78V	2.95V	140°	5.5°C/W
6500K	70		172lm	309lm	2.78V	2.95V	140°	5.5°C/W

说明: 1. NLW3535产品测试电流350mA, 测试时间20毫秒, 环境温度25°C;

2. 发光角度采用美国R.I.公司SIG-400测试, 为50%中心光强夹角, 可提供ProSource Lighttools\tracepro\ASAP\ZEMAX等光学模拟软件需要的光源文档;

3. 因测量技术限制, 产品测试存在测试误差, 应指出ETI光通量和光功率测量值的公差为 $\pm 7\%$, 色坐标 (CCx、CCy) 测量值公差为 ± 0.007 , 显色指数测试值公差为 ± 3 , 电压测试误差 $\pm 0.1\text{V}$ 。

额定参数 Absolute Maximum Ratings

参数名称	符号	额定参数
工作结温 (°C)	T_j	150°C
工作温度 (°C)	T_{op}	-40°C - 120°C
储存温度 (°C)	T_{stg}	-40°C - 120°C
正向电流(3535)	I_F	1500mA
脉冲电流(3535)	I_{FM}	2000mA
反向电压	V_R	无反向操作设计
耐静电电压 (人体模式)	ESD (HBM)	8000V

说明: 1.最大正向电流或最大脉冲正向电流的先决条件是器件结温低于额定工作结温;

2.最大正向脉冲电流基于脉冲时间50毫秒、占空比0.016;

3.内置保护二极管。

产品特征曲线

相对光通量 VS正向电流

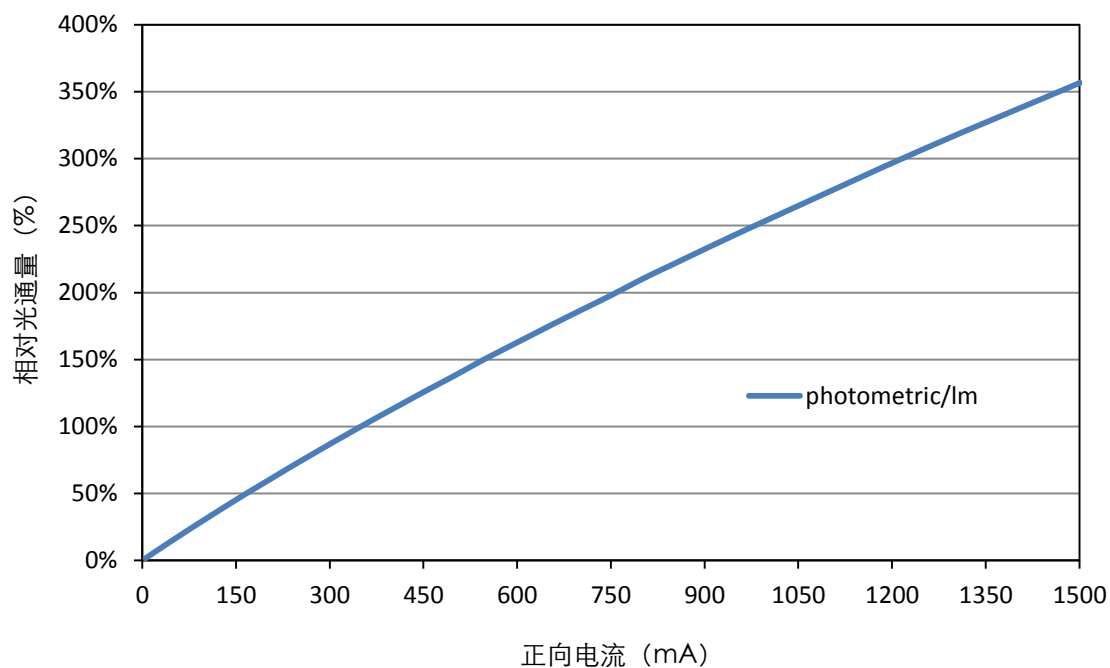

产品特征曲线

正向电流 VS 正向电压

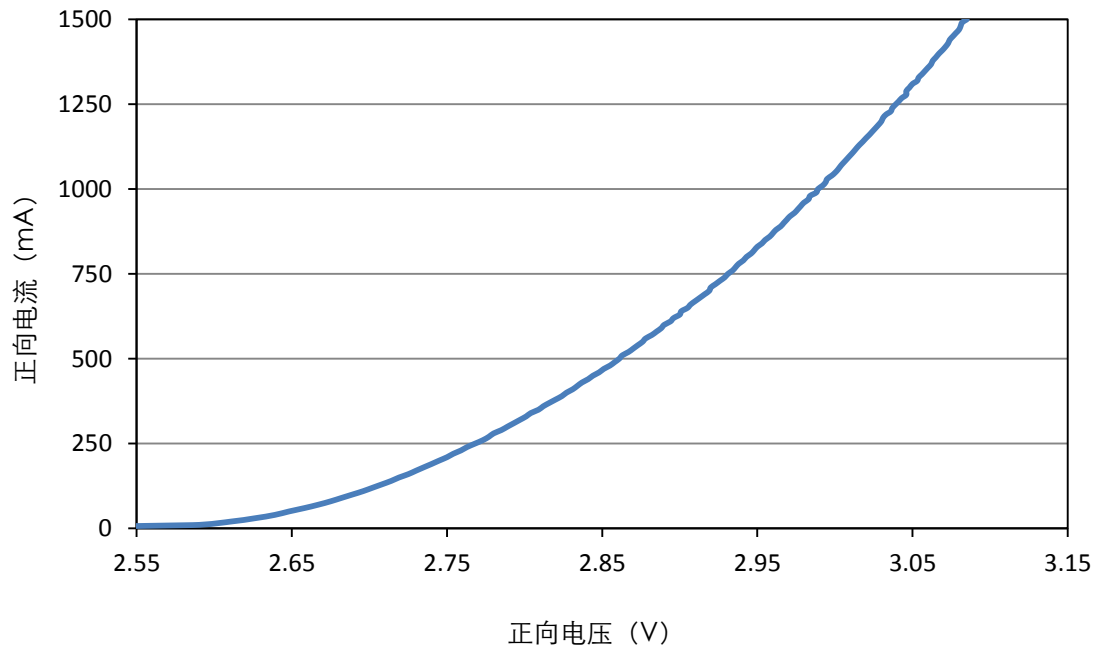

产品特征曲线

正向电压 VS 结温

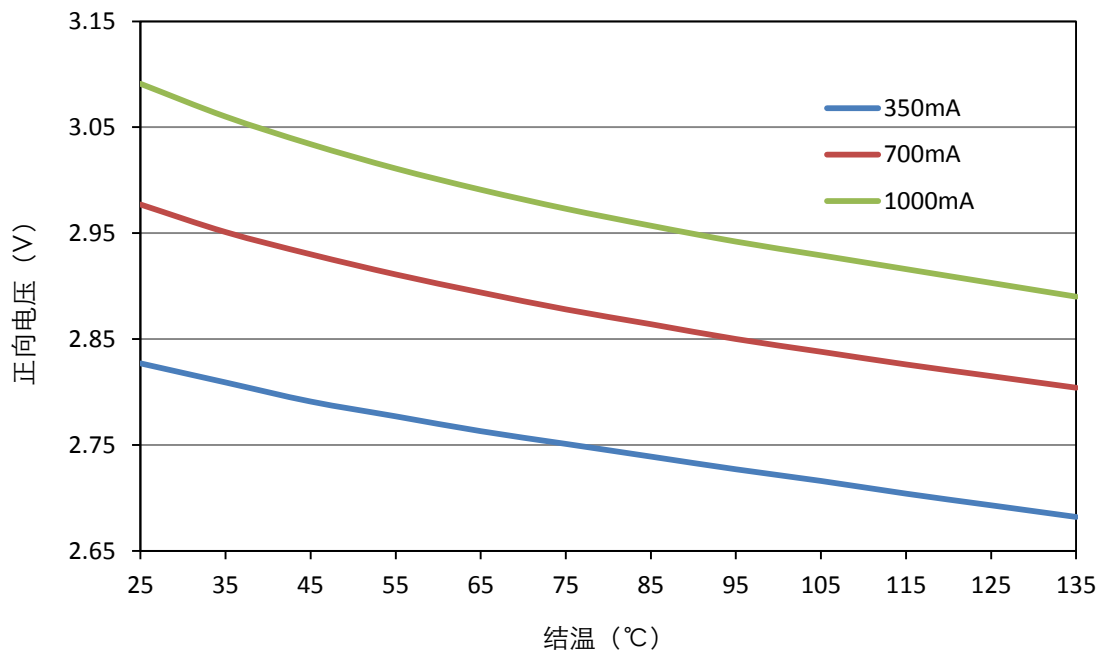

产品特征曲线

相对光通量 VS 结温

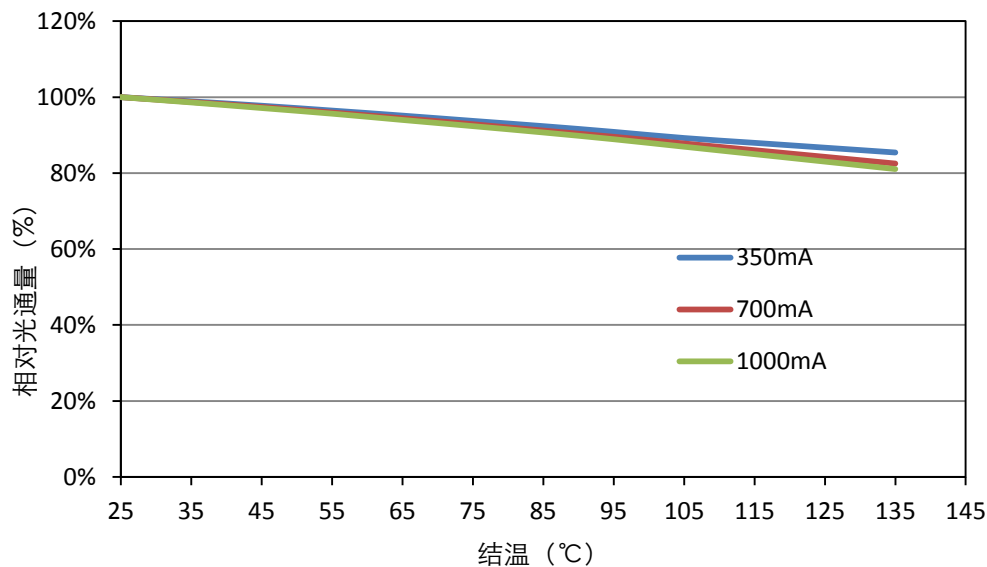

产品特征曲线

相对辐射功率 VS 波长

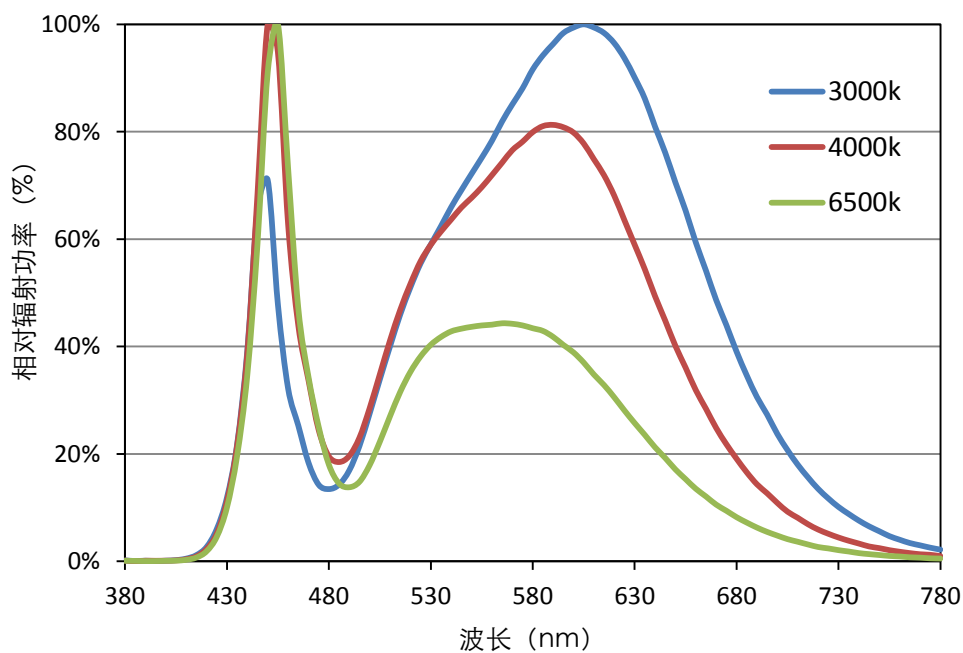

产品特征曲线

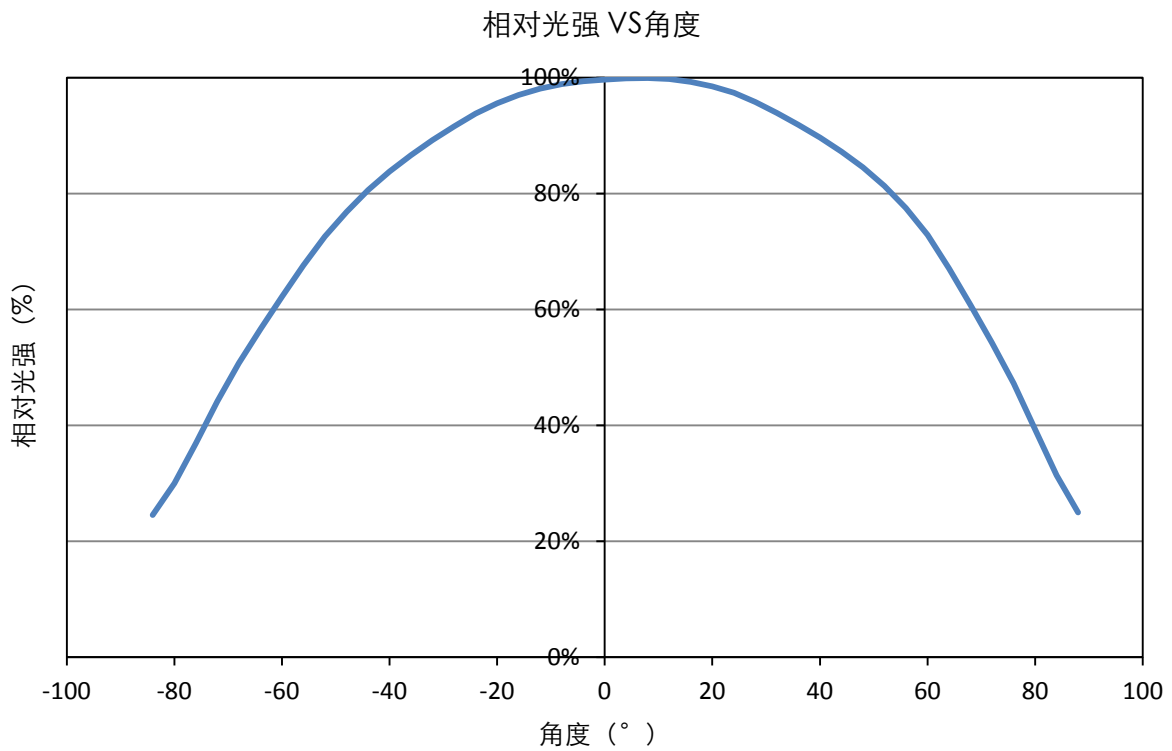

产品特征曲线

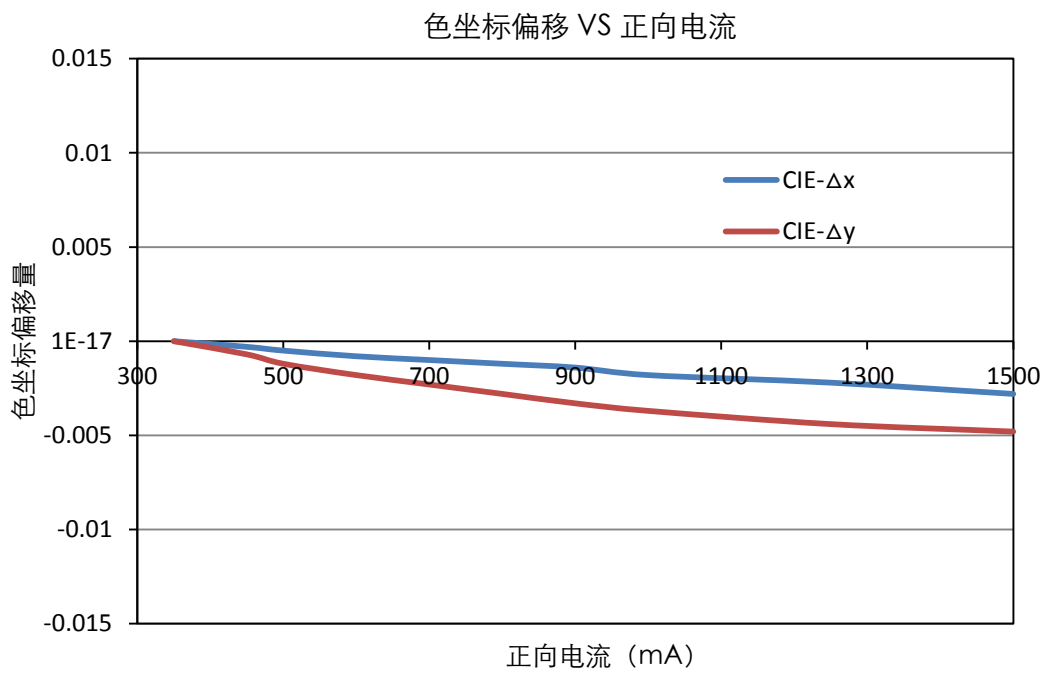

产品特征曲线

色坐标偏移 VS 结温

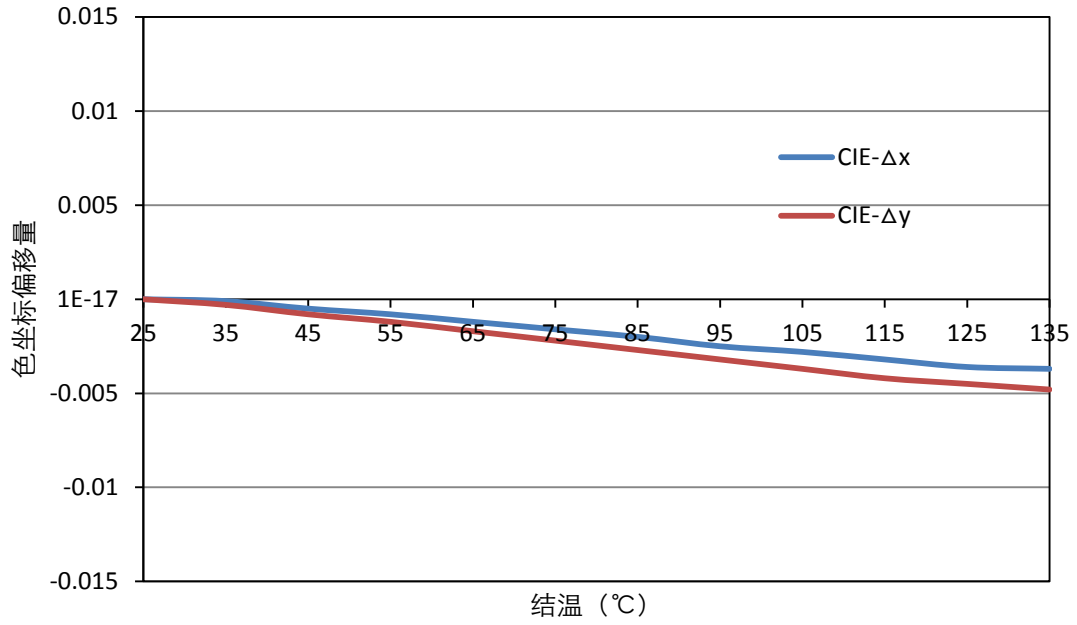

产品尺寸

单位：毫米 (mm) 未注公差：±0.1

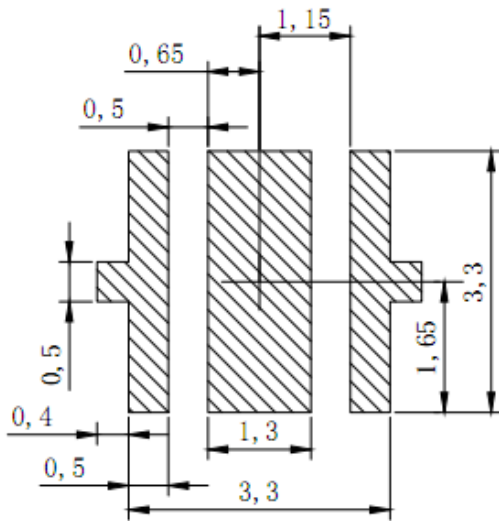
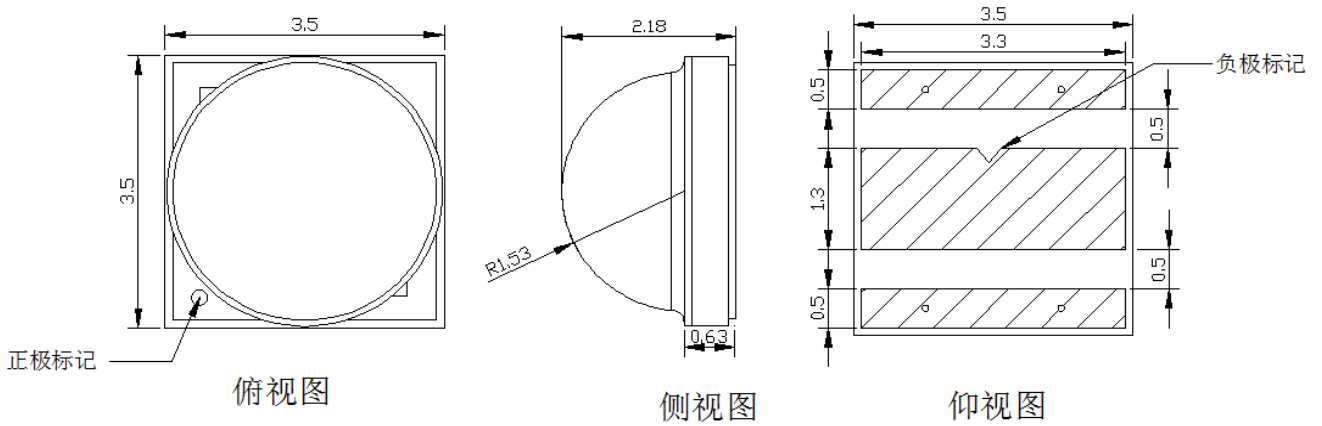

推荐焊盘尺寸

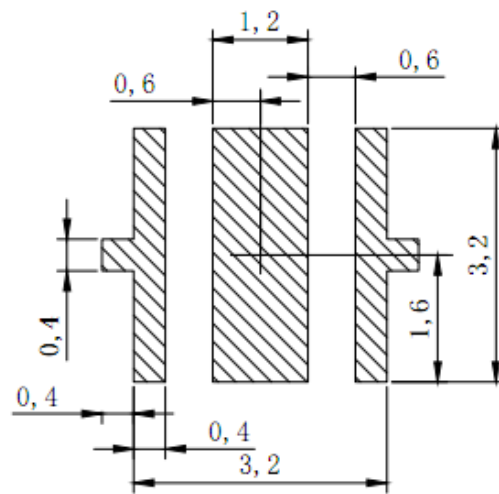

推荐模板尺寸

推荐回流焊温度曲线

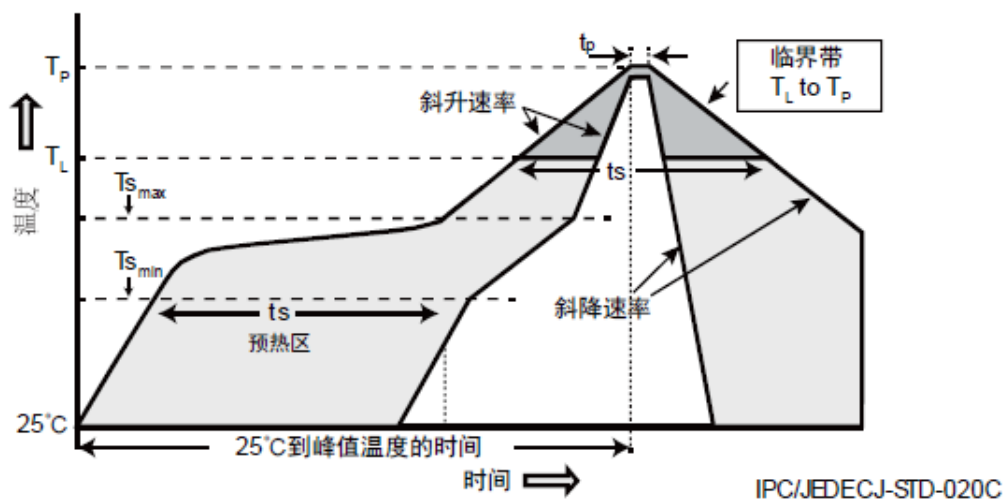

IPC/JEDECJ-STD-020C

温度分布特点	锡铅共晶焊料	无铅焊料
斜升速率 ($T_{s_{max}}$ 到 T_P)	最大值3°C/秒	最大值3°C/秒
最低预热温度 ($T_{s_{min}}$)	100°C	150°C
最高预热温度 ($T_{s_{max}}$)	150°C	200°C
预热时间 ($T_{s_{min}}$ 到 $T_{s_{max}}$)	60-120秒	60-180秒
液相温度 (T_L)	183°C	217°C
温度维持在 T_L 以上的时间 (t_L)	60-150秒	60-150秒
封装体峰值温度 (T_P)	215°C	260°C
指定实际峰值温度5°C内的时间 (t_p)	10-30秒	20-40秒
斜降速率 (T_P 到 T_L)	最大值6°C/秒	最大值6°C/秒
25°C到峰值温度的时间	最大值6分钟	最大值8分钟

说明：1.温度分布特点参照IPC/JEDEC J-STD-020C.

2.产品湿气敏感等级1 (MSL 1)。

湿气敏感度

经过测试证实在不超过30°C/85%相对湿度 (RH) 的条件下, ETi NLW LED的车间寿命不受限制。水分测定包括在85 °C/85%相对湿度条件下先吸湿168小时, 然后进行3次回流焊, 并在每个阶段进行肉眼检查和电气检查。ETi建议: 在立即使用之前, 将NLW LED一直保存在密封的防潮袋中。ETi 还建议: 在使用之后立即将所有未使用的LED放回可重新密封的防潮袋中并封合袋子。

产品命名说明:

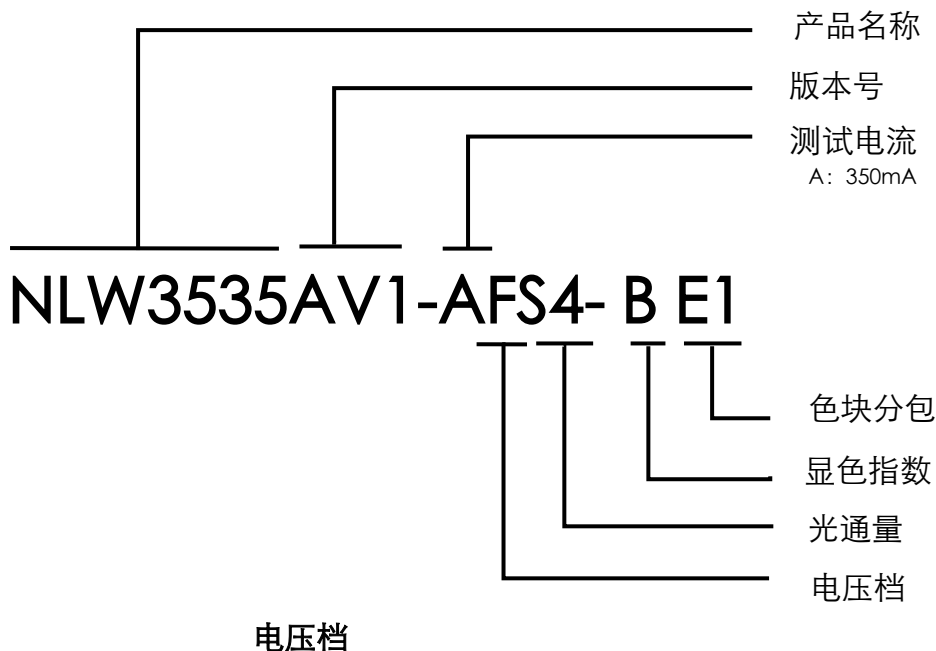

电压档	最小值	最大值	单位
F	2.7	2.95	V

显色指数

显色指数	规格
B	CRI70
H	CRI80

色块分包

色块分包	色温	单位
E1	6500	K
E2	5700	K
E3	5000	K
E4	4500	K
E5	4000	K
E6	3500	K
E7	3000	K
E8	2700	K
E10	2200	K

光通量

光通量	最小值	最大值	单位
Q3	93.9	100	Lm
Q4	100	107	Lm
Q5	107	114	Lm
R2	114	122	Lm
R3	122	130	Lm
R4	130	139	Lm
R5	139	148	Lm
S2	148	156	Lm
S3	156	164	Lm
S4	164	172	Lm
S5	172	182	Lm
S6	182	200	Lm

等温线和分区线不是完全重合，上述色温仅供参考

色块代码说明:

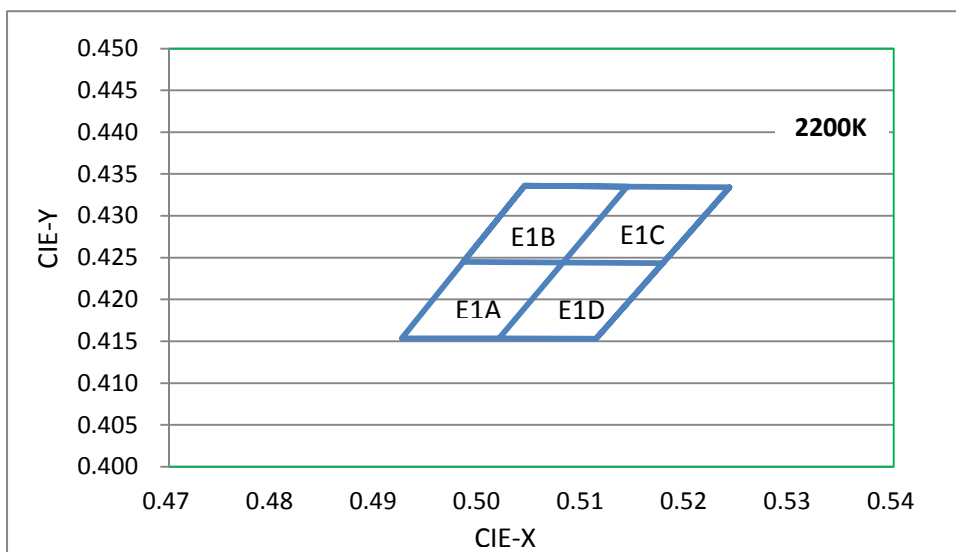
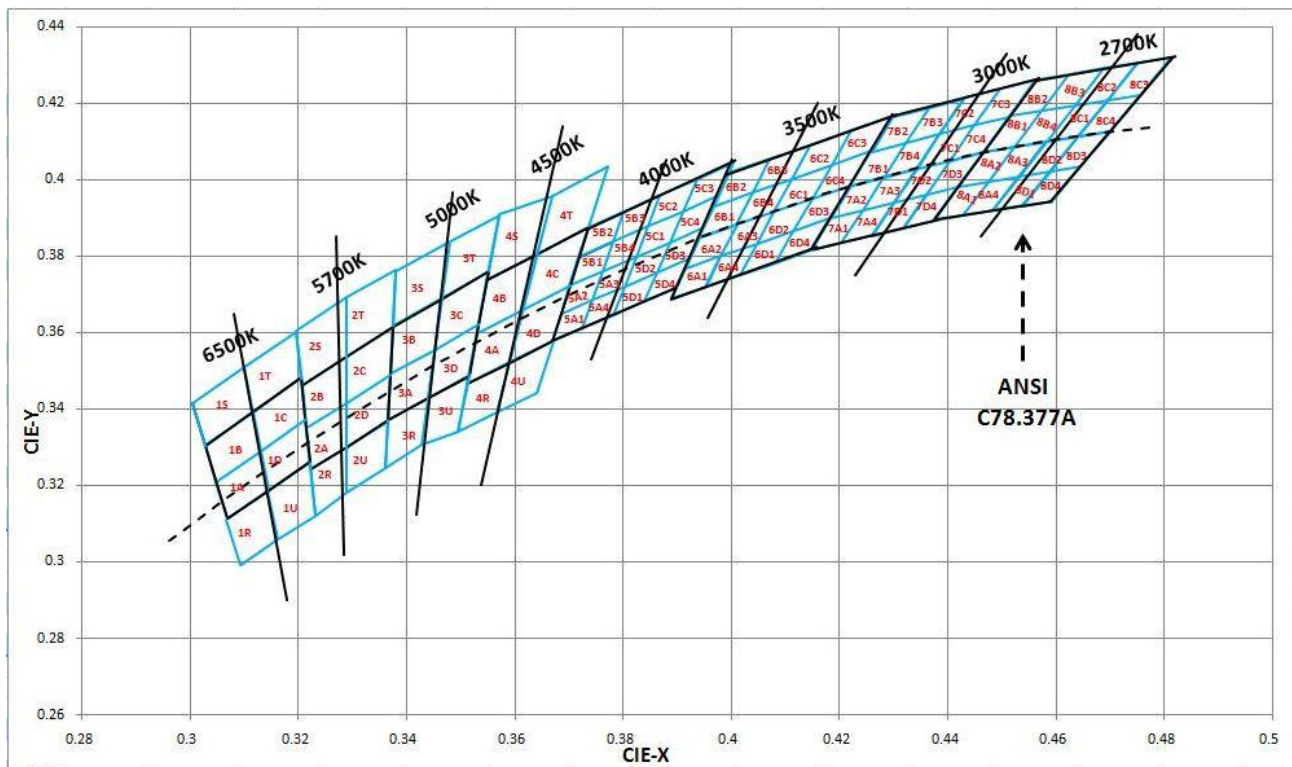

测试误差: 色坐标 (CCx, CCy) 测试误差 ± 0.007

测试电流: 350毫安

测试时间: 20毫秒

环境温度: 25℃

色块——色度坐标

Region	x	y	Region	x	y	Region	x	y	Region	x	y
1A	0.3048	0.3207	1B	0.3028	0.3304	1C	0.3115	0.3391	1D	0.3130	0.3290
	0.3130	0.3290		0.3115	0.3391		0.3205	0.3481		0.3213	0.3373
	0.3144	0.3186		0.3130	0.3290		0.3213	0.3373		0.3221	0.3261
	0.3068	0.3113		0.3048	0.3207		0.3130	0.3290		0.3144	0.3186
1R	0.3068	0.3113	1S	0.3005	0.3415	1T	0.3099	0.3509	1U	0.3144	0.3186
	0.3144	0.3186		0.3099	0.3509		0.3196	0.3602		0.3221	0.3261
	0.3161	0.3059		0.3115	0.3391		0.3205	0.3481		0.3231	0.3120
	0.3093	0.2993		0.3028	0.3304		0.3115	0.3391		0.3161	0.3059
2A	0.3215	0.3350	2B	0.3207	0.3462	2C	0.3290	0.3538	2D	0.3290	0.3417
	0.3290	0.3417		0.3290	0.3538		0.3376	0.3616		0.3371	0.3490
	0.3290	0.3300		0.3290	0.3417		0.3371	0.3490		0.3366	0.3369
	0.3222	0.3243		0.3215	0.3350		0.3290	0.3417		0.3290	0.3300
2R	0.3222	0.3243	2S	0.3196	0.3602	2T	0.3290	0.3690	2U	0.3290	0.3300
	0.3290	0.3300		0.3290	0.3690		0.3381	0.3762		0.3366	0.3369
	0.3290	0.3180		0.3290	0.3538		0.3376	0.3616		0.3361	0.3245
	0.3231	0.3120		0.3207	0.3462		0.3290	0.3538		0.3290	0.3180
3A	0.3371	0.3490	3B	0.3376	0.3616	3C	0.3463	0.3687	3D	0.3451	0.3554
	0.3451	0.3554		0.3463	0.3687		0.3551	0.3760		0.3533	0.3620
	0.3440	0.3427		0.3451	0.3554		0.3533	0.3620		0.3515	0.3487
	0.3366	0.3369		0.3371	0.3490		0.3451	0.3554		0.3440	0.3427
3R	0.3366	0.3369	3S	0.3381	0.3762	3T	0.3480	0.3840	3U	0.3440	0.3428
	0.3440	0.3428		0.3480	0.3840		0.3571	0.3907		0.3515	0.3487
	0.3429	0.3307		0.3463	0.3687		0.3551	0.3760		0.3495	0.3339
	0.3361	0.3245		0.3376	0.3616		0.3463	0.3687		0.3429	0.3307
4A	0.3530	0.3597	4B	0.3548	0.3736	4C	0.3641	0.3804	4D	0.3615	0.3659
	0.3615	0.3659		0.3641	0.3804		0.3736	0.3874		0.3702	0.3722
	0.3590	0.3521		0.3615	0.3659		0.3702	0.3722		0.3670	0.3578
	0.3512	0.3465		0.3530	0.3597		0.3615	0.3659		0.3590	0.3521
4R	0.3512	0.3465	4S	0.3571	0.3907	4T	0.3668	0.3957	4U	0.3590	0.3521
	0.3590	0.3521		0.3668	0.3957		0.3771	0.4034		0.3670	0.3578
	0.3567	0.3389		0.3641	0.3804		0.3736	0.3874		0.3640	0.3440
	0.3495	0.3339		0.3548	0.3736		0.3641	0.3804		0.3567	0.3389
5A	0.3702	0.3722	5B	0.3736	0.3874	5C	0.3870	0.3958	5D	0.3825	0.3798
	0.3825	0.3798		0.3870	0.3958		0.4006	0.4044		0.3951	0.3876
	0.3783	0.3646		0.3825	0.3798		0.3951	0.3876		0.3898	0.3716
	0.3670	0.3578		0.3702	0.3722		0.3825	0.3798		0.3783	0.3646
5A1	0.3670	0.3578	5A2	0.3686	0.3649	5A3	0.3744	0.3685	5A4	0.3726	0.3612
	0.3686	0.3649		0.3702	0.3722		0.3763	0.3760		0.3744	0.3685
	0.3744	0.3685		0.3763	0.3760		0.3825	0.3798		0.3804	0.3721
	0.3726	0.3612		0.3744	0.3685		0.3804	0.3721		0.3783	0.3646

色块——色度坐标 (继续)

Region	x	y	Region	x	y	Region	x	y	Region	x	y
5B1	0.3702	0.3722	5B2	0.3719	0.3797	5B3	0.3782	0.3837	5B4	0.3763	0.3760
	0.3719	0.3797		0.3736	0.3874		0.3802	0.3916		0.3782	0.3837
	0.3782	0.3837		0.3802	0.3916		0.3869	0.3958		0.3847	0.3877
	0.3763	0.3760		0.3782	0.3837		0.3847	0.3877		0.3825	0.3798
5C1	0.3825	0.3798	5C2	0.3847	0.3877	5C3	0.3912	0.3917	5C4	0.3887	0.3836
	0.3847	0.3877		0.3869	0.3958		0.3937	0.4001		0.3912	0.3917
	0.3912	0.3917		0.3937	0.4001		0.4006	0.4044		0.3978	0.3958
	0.3887	0.3836		0.3912	0.3917		0.3978	0.3958		0.3950	0.3875
5D1	0.3783	0.3646	5D2	0.3804	0.3721	5D3	0.3863	0.3758	5D4	0.3840	0.3681
	0.3804	0.3721		0.3825	0.3798		0.3887	0.3836		0.3863	0.3758
	0.3863	0.3758		0.3887	0.3836		0.3950	0.3875		0.3924	0.3794
	0.3840	0.3681		0.3863	0.3758		0.3924	0.3794		0.3898	0.3716
6A	0.3941	0.3848	6B	0.3996	0.4015	6C	0.4146	0.4089	6D	0.4080	0.3916
	0.4080	0.3916		0.4146	0.4089		0.4299	0.4165		0.4221	0.3985
	0.4017	0.3752		0.4080	0.3916		0.4221	0.3985		0.4147	0.3814
	0.3889	0.369		0.3941	0.3848		0.4080	0.3916		0.4017	0.3752
6A1	0.3889	0.3690	6A2	0.3915	0.3768	6A3	0.3981	0.3800	6A4	0.4080	0.3916
	0.3915	0.3768		0.3941	0.3848		0.4010	0.3882		0.3981	0.3800
	0.3981	0.3800		0.4010	0.3882		0.4080	0.3916		0.4048	0.3832
	0.3953	0.3720		0.3981	0.3800		0.4048	0.3832		0.4017	0.3751
6B1	0.3941	0.3848	6B2	0.3968	0.3930	6B3	0.4040	0.3966	6B4	0.4010	0.3882
	0.3968	0.3930		0.3996	0.4015		0.4071	0.4052		0.4040	0.3966
	0.4040	0.3966		0.4071	0.4052		0.4146	0.4089		0.4113	0.4001
	0.4010	0.3882		0.4040	0.3966		0.4113	0.4001		0.4080	0.3916
6C1	0.4080	0.3916	6C2	0.4113	0.4001	6C3	0.4186	0.4037	6C4	0.4150	0.3950
	0.4113	0.4001		0.4146	0.4089		0.4222	0.4127		0.4186	0.4037
	0.4186	0.4037		0.4222	0.4127		0.4299	0.4165		0.4259	0.4073
	0.4150	0.3950		0.4186	0.4037		0.4259	0.4073		0.4221	0.3984
6D1	0.4017	0.3751	6D2	0.4048	0.3832	6D3	0.4116	0.3865	6D4	0.4062	0.3782
	0.4048	0.3832		0.4080	0.3916		0.4150	0.3950		0.4116	0.3865
	0.4116	0.3865		0.4150	0.3950		0.4221	0.3984		0.4183	0.3898
	0.4082	0.3782		0.4116	0.3865		0.4183	0.3898		0.4147	0.3814
7A	0.4221	0.3985	7B	0.4299	0.4165	7C	0.4430	0.4212	7D	0.4342	0.4028
	0.4342	0.4028		0.4430	0.4212		0.4562	0.426		0.4465	0.4071
	0.4260	0.3853		0.4342	0.4028		0.4465	0.4071		0.4373	0.3893
	0.4147	0.3814		0.4221	0.3985		0.4342	0.4028		0.4260	0.3853
7A1	0.4147	0.3814	7A2	0.4183	0.3898	7A3	0.4242	0.3919	7A4	0.4203	0.3833
	0.4183	0.3898		0.4221	0.3984		0.4281	0.4006		0.4242	0.3919
	0.4242	0.3919		0.4281	0.4006		0.4342	0.4028		0.4300	0.3939
	0.4203	0.3833		0.4242	0.3919		0.4300	0.3939		0.4259	0.3853

色块——色度坐标 (继续)

Region	x	y	Region	x	y	Region	x	y	Region	x	y
7B1	0.4221	0.3984	7B2	0.4259	0.4073	7B3	0.4322	0.4096	7B4	0.4281	0.4006
	0.4259	0.4073		0.4299	0.4165		0.4364	0.4188		0.4322	0.4096
	0.4322	0.4096		0.4364	0.4188		0.4430	0.4212		0.4385	0.4119
	0.4281	0.4006		0.4322	0.4096		0.4385	0.4119		0.4342	0.4028
7C1	0.4342	0.4028	7C2	0.4385	0.4119	7C3	0.4449	0.4141	7C4	0.4403	0.4049
	0.4385	0.4119		0.4430	0.4212		0.4496	0.4236		0.4449	0.4141
	0.4449	0.4141		0.4496	0.4236		0.4562	0.4260		0.4513	0.4164
	0.4403	0.4049		0.4449	0.4141		0.4513	0.4164		0.4465	0.4071
7D1	0.4259	0.3853	7D2	0.4300	0.3939	7D3	0.4359	0.3960	7D4	0.4316	0.3873
	0.4300	0.3939		0.4342	0.4028		0.4403	0.4049		0.4359	0.3960
	0.4359	0.3960		0.4403	0.4049		0.4465	0.4071		0.4418	0.3981
	0.4316	0.3873		0.4359	0.3960		0.4418	0.3981		0.4373	0.3893
8A	0.4465	0.4071	8B	0.4562	0.4260	8C	0.4687	0.4289	8D	0.4582	0.4099
	0.4582	0.4099		0.4687	0.4289		0.4813	0.4319		0.4700	0.4126
	0.4483	0.3918		0.4582	0.4099		0.4700	0.4126		0.4593	0.3944
	0.4373	0.3893		0.4465	0.4071		0.4582	0.4099		0.4483	0.3918
8A1	0.4373	0.3893	8A2	0.4418	0.3981	8A3	0.4475	0.3994	8A4	0.4428	0.3906
	0.4418	0.3981		0.4465	0.4071		0.4523	0.4085		0.4475	0.3994
	0.4475	0.3994		0.4523	0.4085		0.4582	0.4099		0.4532	0.4008
	0.4428	0.3906		0.4475	0.3994		0.4532	0.4008		0.4483	0.3919
8B1	0.4465	0.4071	8B2	0.4513	0.4164	8B3	0.4573	0.4178	8B4	0.4523	0.4085
	0.4513	0.4164		0.4562	0.4260		0.4624	0.4274		0.4573	0.4178
	0.4573	0.4178		0.4624	0.4274		0.4687	0.4289		0.4634	0.4193
	0.4523	0.4085		0.4573	0.4178		0.4634	0.4193		0.4582	0.4099
8C1	0.4582	0.4099	8C2	0.4634	0.4139	8C3	0.4695	0.4207	8C4	0.4641	0.4112
	0.4634	0.4193		0.4687	0.4289		0.4750	0.4304		0.4695	0.4207
	0.4695	0.4207		0.4750	0.4304		0.4813	0.4319		0.4756	0.4221
	0.4641	0.4112		0.4695	0.4207		0.4756	0.4221		0.4700	0.4126
8D1	0.4483	0.3919	8D2	0.4532	0.4008	8D3	0.4589	0.4021	8D4	0.4538	0.3931
	0.4352	0.4008		0.4582	0.4099		0.4641	0.4112		0.4589	0.4021
	0.4589	0.4021		0.4641	0.4112		0.4700	0.4126		0.4646	0.4034
	0.4538	0.3931		0.4589	0.4021		0.4646	0.4034		0.4593	0.3944
E1A	0.4925	0.4154	E1B	0.4984	0.4245	E1C	0.5081	0.4244	E1D	0.5019	0.4153
	0.4984	0.4245		0.5043	0.4336		0.5143	0.4335		0.5081	0.4244
	0.5081	0.4244		0.5143	0.4335		0.5242	0.4334		0.5177	0.4244
	0.5019	0.4153		0.5081	0.4244		0.5177	0.4244		0.5113	0.4153

色块分包代码:

Color	Kit	Chromaticity Bins
Cool White	E1	1A,1B,1C,1D
	E2	2A,2B,2C,2D
	E3	3A,3B,3C,3D
Neutral White	E4	4A,4B,4C,4D
	E5	5A1,5A2,5A3,5A4,5B1,5B2,5B3,5B4,5C1,5C2,5C3,5C4,5D1,5D2,5D3,5D4
	E6	6A1,6A2,6A3,6A4,6B1,6B2,6B3,6B4,6C1,6C2,6C3,6C4,6D1,6D2,6D3,6D4
Warm White	E7	7A1,7A2,7A3,7A4,7B1,7B2,7B3,7B4,7C1,7C2,7C3,7C4,7D1,7D2,7D3,7D4
	E8	8A1,8A2,8A3,8A4,8B1,8B2,8B3,8B4,8C1,8C2,8C3,8C4,8D1,8D2,8D3,8D4
Amber	E10	E1A,E1B,E1C,E1D

订购分包说明:

白光LED的产出一般包含多个色块，基于成本的考虑，建议订购多个色块。

供参考的色块分包有:

E1、E2、E3、E4、E5、E6、E7、E8、E10